



FERVE

FAST

F-923

F-925

F-970

F-925 RF

F-970 RF

CE





- Lea el manual de instrucciones antes de usar el cargador.
- Read the instruction manual before using the charger.
- Veuillez lire le manuel d'instructions avant d'utiliser le chargeur.
- Bitte lesen Sie diese Gebrauchsanleitung vor der Benutzung des Ladegeräts sorgfältig durch.
- Lees de gebruiksaanwijzing alvorens U de lader gaat gebruiken.



- Evite las llamas y chispas.
- Avoid flames and sparks.
- Eviter flammes et étincelles.
- Offene Flammen und Funken.
- Vermijdt vuur en vonken.



- ¡Atención! Gas explosivo.
- Attention! Explosive gas.
- Attention! Gaz explosif.
- Achtung! Explosionsgefahr durch Gas.
- Let op! Knalgas.



- No exponga el aparato a la lluvia.
- Do not expose the equipment to rain.
- N'exposez pas l'appareil à la pluie.
- Setzen Sie das Gerät nicht dem Regen Aus.
- Zet het apparaat niet in de regen.



- Utilícelo en un lugar ventilado.
- Use it in a well-ventilated place.
- Utilisez-le dans un lieu aéré.
- Benutzen Sie das Gerät in einem belüfteten Raum.
- Gebruik het apparaat in een geventileerde ruimte.

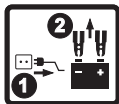

- Desconecte el cable de red (1) antes de conectar o desconectar las pinzas (2).
- Disconnect the mains cable (1) before connecting or disconnecting the clamps (2).
- Débranchez le câble du secteur (1) avant de brancher ou de débrancher les pinces (2).
- Ziehen Sie bitte den Netzkabel (1), bevor Sie die Zangen anschließen oder abklemmen (2).
- Maak de kabel los van het net (1) alvorens de klemmen te koppelen of te ontkoppelen (2).

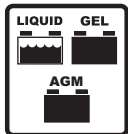

- Sólo para baterías de plomo-ácido.
- For lead-acid batteries only.
- Uniquement pour batterie à plomb-acide.
- Nur für Bleisäurebatterien.
- Alleen geschikt voor Lood accu's.



- No lo use para recargar pilas.
- Do not use it to charge battery cells.
- Ne l'utilisez pas pour recharger les piles.
- Benutzen Sie das Gerät nicht, um Batterien aufzuladen, die keine Autobatterien sind.
- Gebruik de lader niet om batterijen te herladen.



- El ácido de las baterías es corrosivo.
- Battery acid is corrosive.
- L'acide des batteries est corrosif.
- Die Säure der Batterie ist korrosiv.
- Het accuzuur is corrosief.



- Tenga en cuenta las indicaciones del fabricante de las baterías.
- Bear in mind the instructions provided by the battery manufacturer.
- Tenir compte des indications du fabricant des batteries.
- Die Anweisungen des Batterieherstellers müssen beachtet werden.
- Houd rekening met de aanwijzingen van de accu fabrikant.



- El cable de red sólo puede ser sustituido en un taller especializado.
- The wire to the mains can only be replaced at a specialized workshop.
- Le câble d'alimentation au secteur ne peut être remplacé que dans un atelier spécialisé.
- Das Stromkabel darf nur in einer spezialisierten Werkstatt ausgewechselt werden.
- Voedingsspanningskabels mogen alleen door geautoriseerde dealers worden vervangen.



- Tenga en cuenta las indicaciones del fabricante del vehículo.
- Bear in mind the instructions provided by the vehicle manufacturer.
- Tenir compte des indications du fabricant du véhicule.
- Die Anweisungen des Autoherstellers müssen beachtet werden.
- Houd rekening met de aanwijzingen van de auto fabrikant.



A
arith.

A
eff.

BOOSTER

F-923

230 V
50/60 Hz

12 - 24 V

40 - 20 A

57 - 28 A

150 A

F-925

230 V
50/60 Hz

12 - 24 V

55 - 35 A

77 - 49 A

250 A

F-925 RF

230 V
50/60 Hz

12 - 24 V

55 - 35 A

55 - 35 A

250 A

F-970

230 V
50/60 Hz

12 - 24 V

70 - 55 A

105 - 80 A

450 A

F-970 RF

230 V
50/60 Hz

12 - 24 V

70 - 55 A

70 - 55 A

450 A

RF RIPPLE FREE

E

Los cargadores RF "Ripple Free" permiten cargar la batería sin desconectarla del vehículo, eliminando la componente alterna y los picos de tensión, a la vez que protegen las memorias y los dispositivos electrónicos.

GB

The RF 'Ripple Free' chargers enable the battery to be charged without disconnecting it from the vehicle, eliminating the alternating component and voltage peaks while protecting memories and electronic devices.

F

Les chargeurs RF « Ripple Free » permettent de charger la batterie sans la déconnecter du véhicule, supprimant la composante alternative de sortie du chargeur et les pointes de tension, tout en protégeant les mémoires et les accessoires électroniques embarqués.

D

Mit Hilfe der Ladegeräte RF "Ripple Free" kann die Batterie geladen werden, ohne sie vom Fahrzeug abzuklemmen, wodurch die Wechselstromkomponente sowie Spannungsspitzen vermieden und gleichzeitig der Speicher und die elektronischen Bauelemente geschützt werden.

NL

De RF "Ripple Free" of rimpelvrije laders laten toe de accu te laden zonder de wagen uit te schakelen door de wisselspanning en overspanning weg te houden en de geheugens en elektronische componenten te beschermen.

E VERIFICACIÓN DE LA POLARIDAD

GB CHECKING POLARITY

F VÉRIFICATION DE LA POLARITÉ

D POLARITÄTSPRÜFUNG

NL CONTROLE POLARITEIT

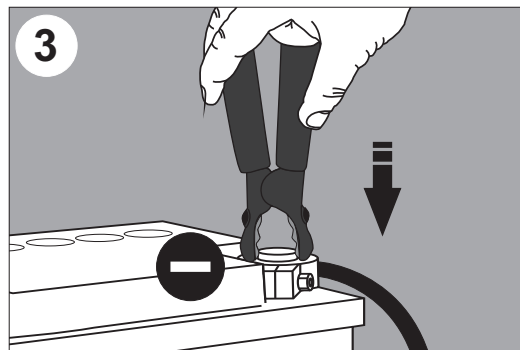
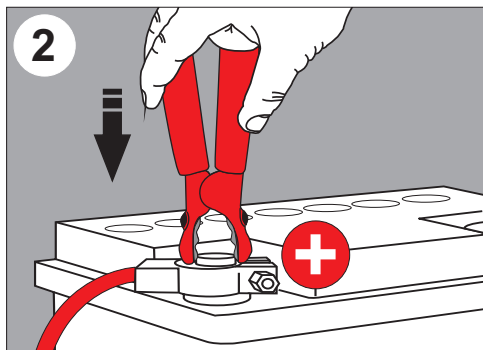
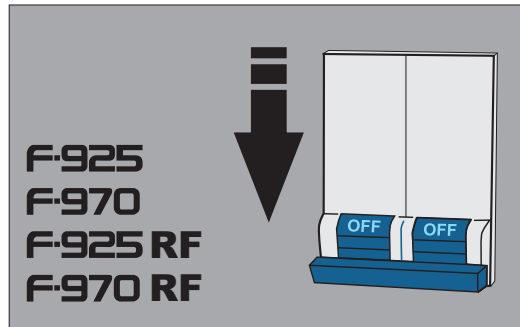
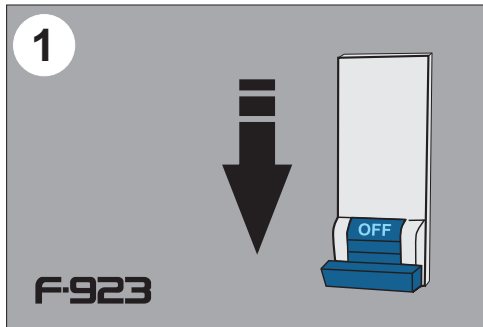

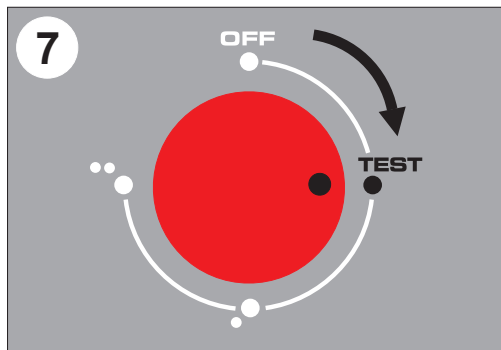
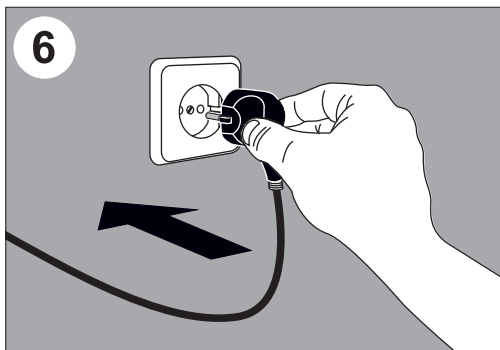
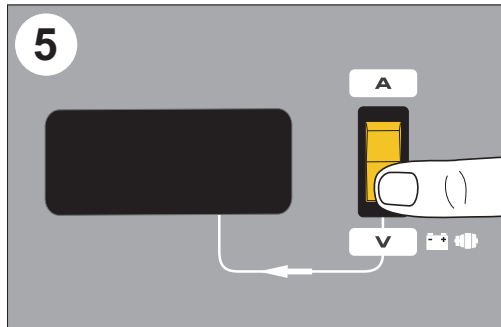
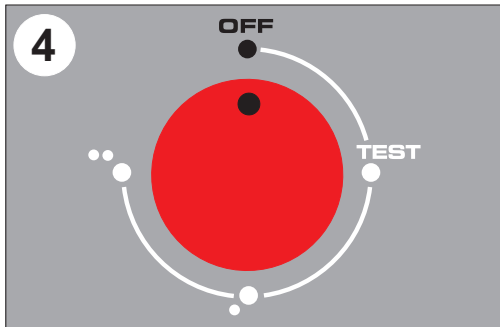

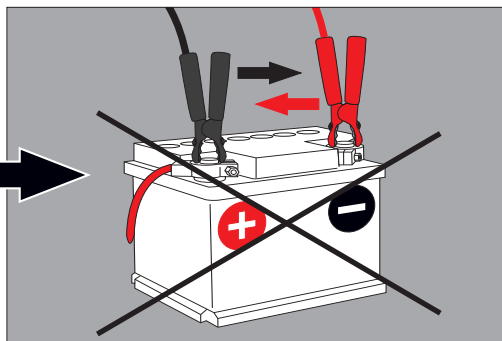
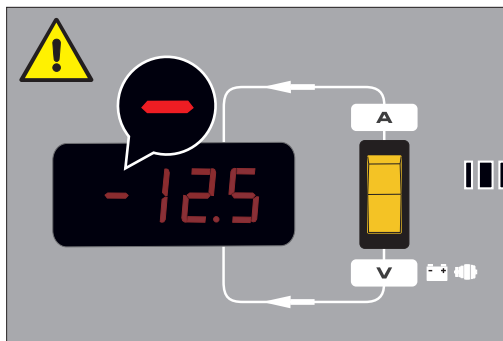
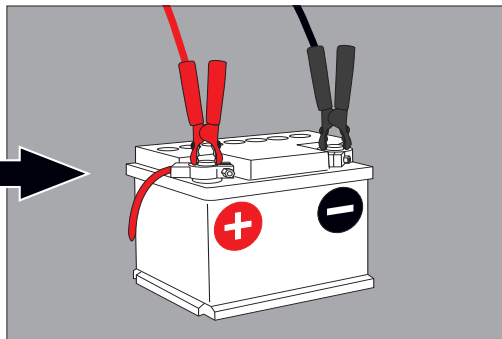
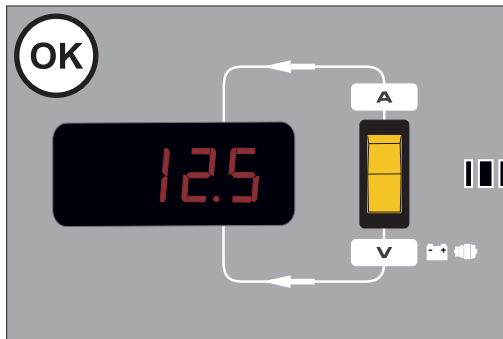

E COMPROBACIÓN DEL ESTADO DE CARGA DE LA BATERÍA (MOTOR DEL VEHÍCULO PARADO)

GB TESTING THE BATTERY CONDITION (WITH STOPPED ENGINE)

F VÉRIFICATION DE L'ÉTAT DE CHARGE DE LA BATTERIE (MOTEUR DU VÉHICULE À L'ARRÊT)

D ÜBERPRÜFUNG DES LADEZUSTANDS DER BATTERIE (BEI ABGESCHALTETEM MOTOR)

NL HET TESTEN VAN DE ACCU CONDITIE (MET STILSTAANDE MOTOR)

1 - 7 PAG. 8-10

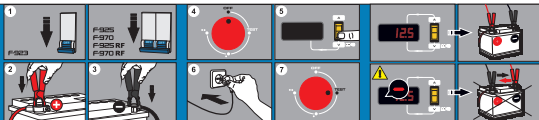

FERVE
CARGADOR DE BATERIAS
BATTERY CHARGER

12 V LIQUID	12 V GEL	12 V AGM	24 V LIQUID	24 V GEL	24 V AGM	%
< 11.9	< 12.1	< 12	< 23.8	< 24.2	< 24	< 20%
12.1	12.3	12.2	24.3	24.5	24.4	25%
12.3	12.5	12.4	24.6	25	24.8	50%
12.5	12.8	12.6	25	25.5	25.2	75%
12.7	13	12.8	25.4	26	25.6	100%

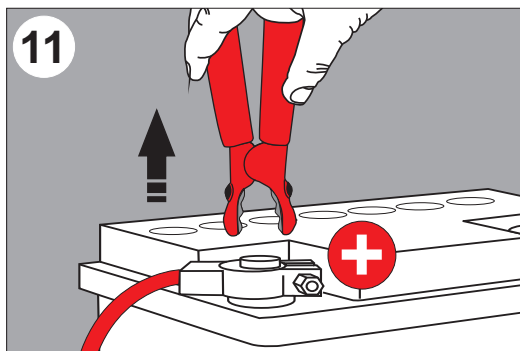
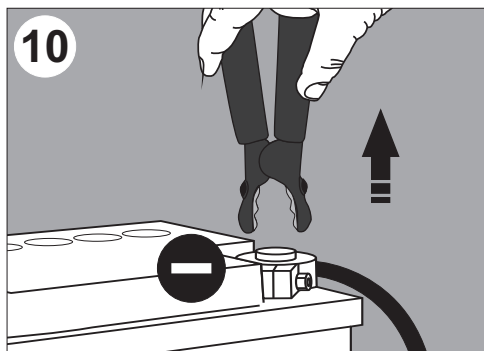
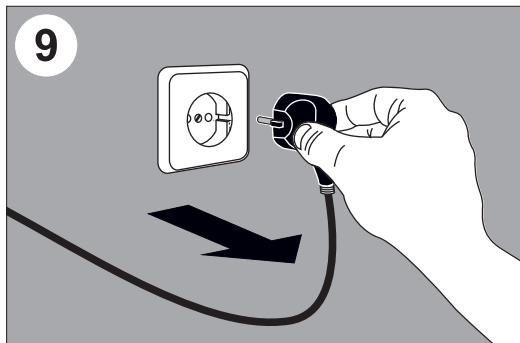
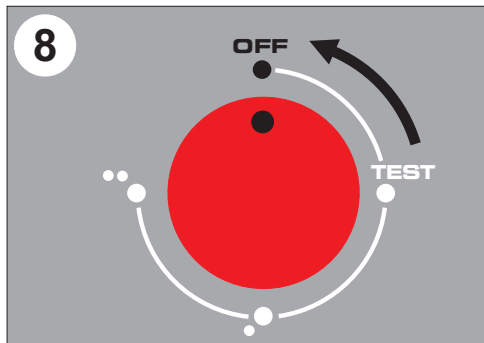



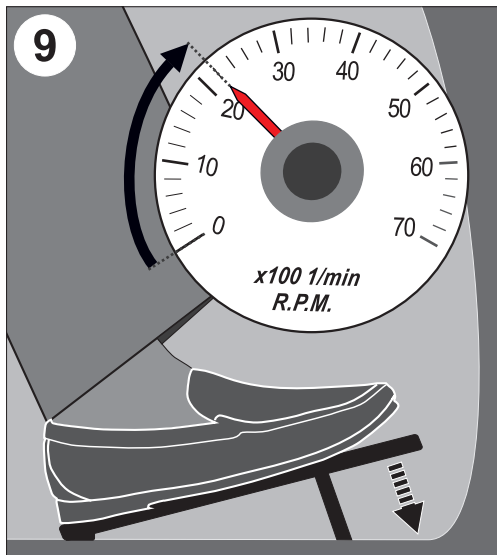
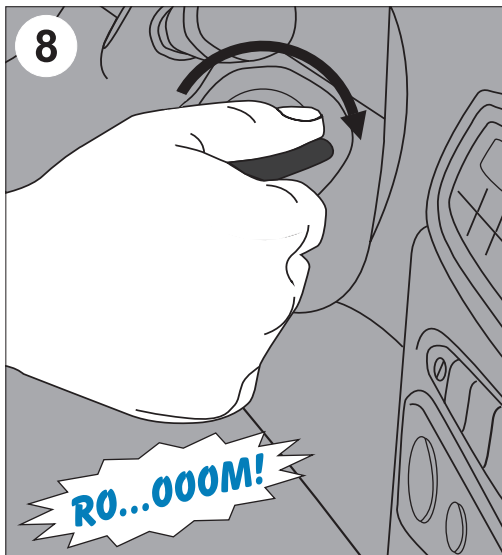
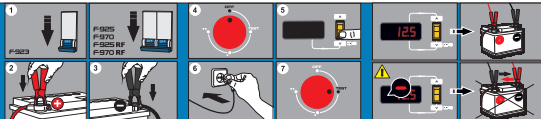

- E** COMPROBACIÓN DEL FUNCIONAMIENTO DEL ALTERNADOR (MOTOR DEL VEHÍCULO EN MARCHA)
- GB** CHECKING THE ALTERNATOR (WITH STARTER ENGINE)
- F** VÉRIFICATION DU FONCTIONNEMENT DE L'ALTERNATEUR (MOTEUR DU VÉHICULE EN MARCHÉ)
- D** BETRIEBSÜBERPRÜFUNG DES WECHSELSTROMGENERATORS (BEI EINGESCHALTETEM MOTOR)
- NL** HET TESTEN VAN DE DYNAMO (MET DRAAIENDE MOTOR)

1 - 7 PAG. 8-10





 12 V	 24 V	
< 13.3	< 26.3	 BAJO LOW BAS ZWAK NIEDRIG
13.3 - 14.8	26.3 - 29.6	 OK
> 14.8	> 29.6	 ALTO HIGH HAUT HOOG

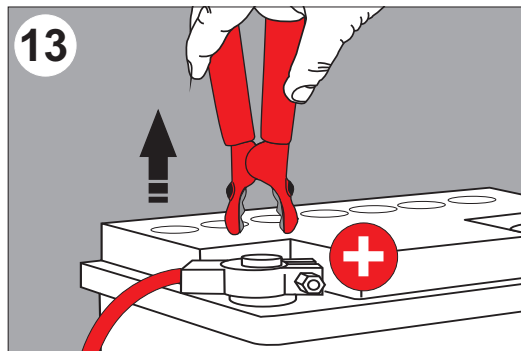
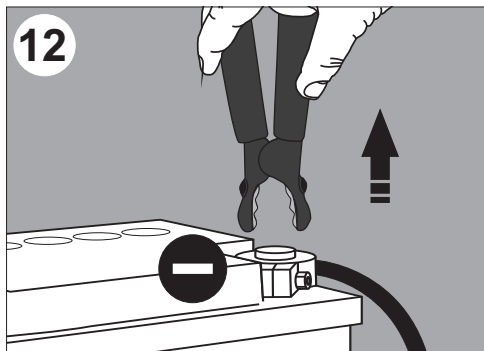
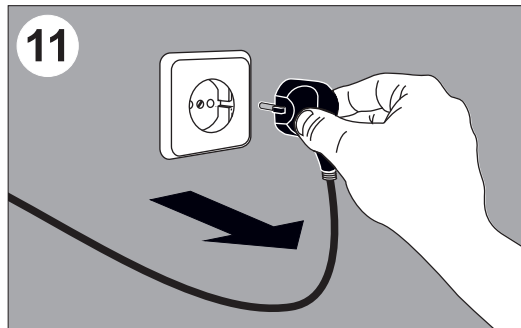
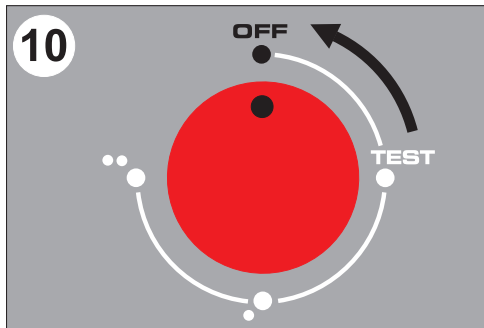

E

**PROCESO DE CARGA DE LA BATERÍA
CARGA NORMAL**

GB

**BATTERY CHARGING PROCESS
NORMAL CHARGE**

F

**PROCESSUS DE CHARGE DE LA BATTERIE
CHARGE NORMAL**

D

**LADEPROZESS DER BATTERIE
NORMALBELADUNG**

NL

**LAADPROCES VAN DE ACCU
NORMAAL LADEN**



PAG.8-12

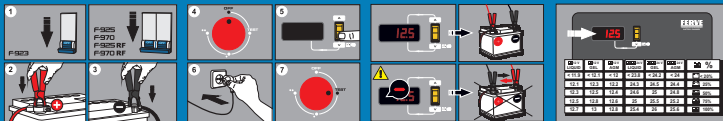

8

AUTOMATIC



MANUAL

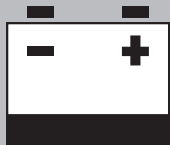

< 25%

AUTOMATIC



MANUAL

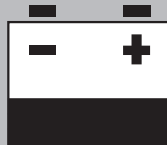

> 30%

9

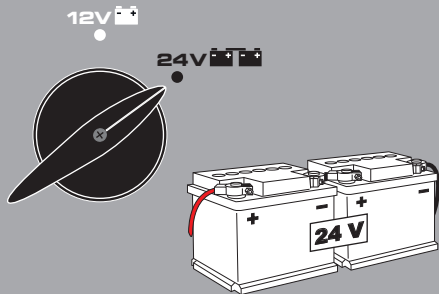
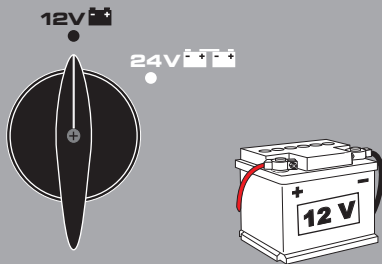

10

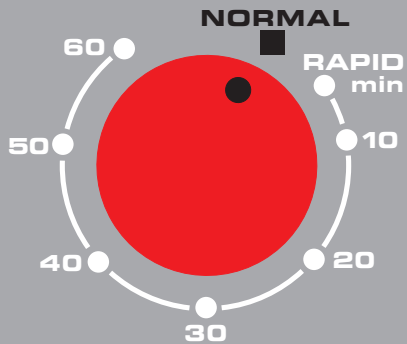

11

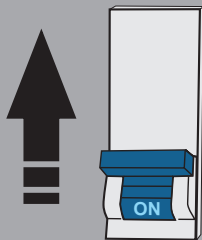

F-923



F-925
F-970
F-925 RF
F-970 RF

12

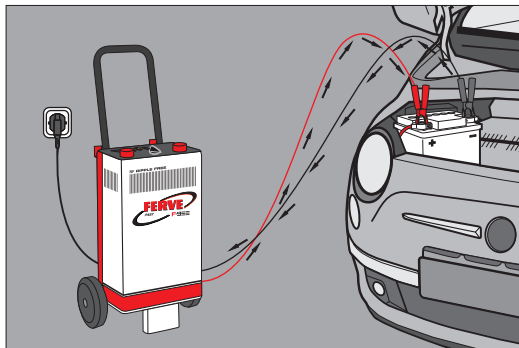
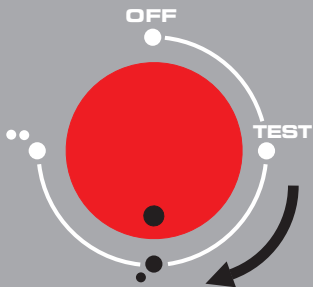

MANUAL

12V

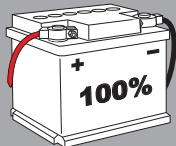

14.8



14.4



14.6

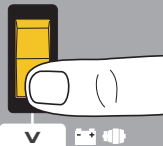

V



24V

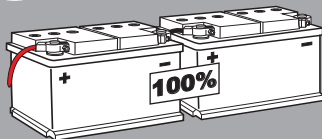

29.6



28.8



29.2

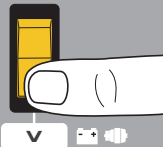

V



AUTOMATIC

12V

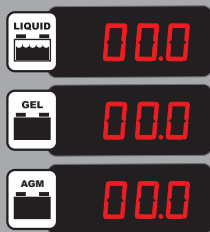
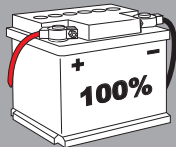

24V

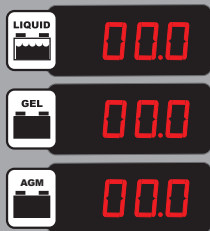
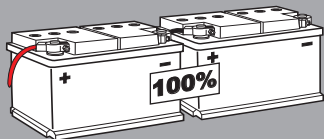

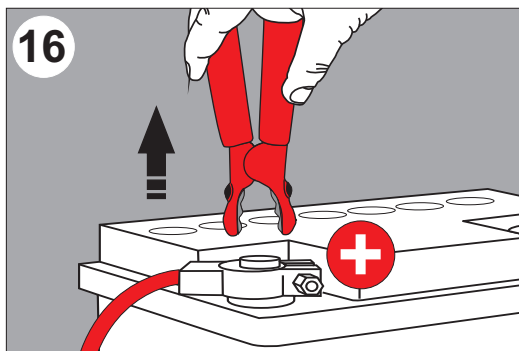
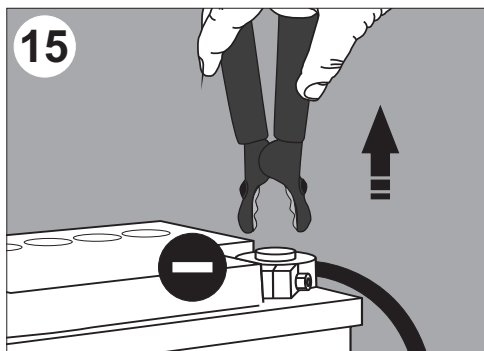
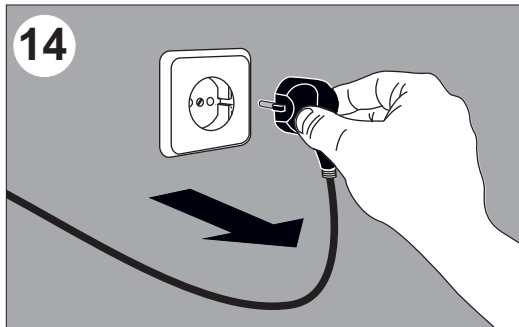
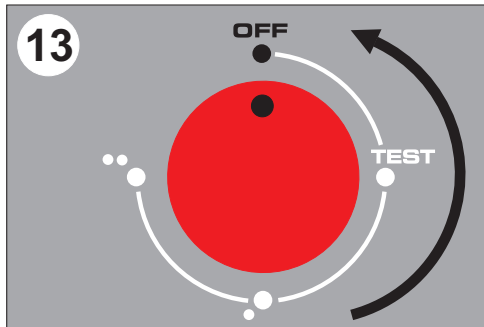

E

**PROCESO DE CARGA DE LA BATERÍA
CARGA RÁPIDA**

GB

**BATTERY CHARGING PROCESS
FAST CHARGE**

F

**PROCESSUS DE CHARGE DE LA BATTERIE
CHARGE RAPIDE**

D

**LADEPROZESS DER BATTERIE
SCHNELLBELADUNG**

NL

**LAADPROCES VAN DE ACCU
SNEL LADEN**

1 - 7 PAG. 8-10

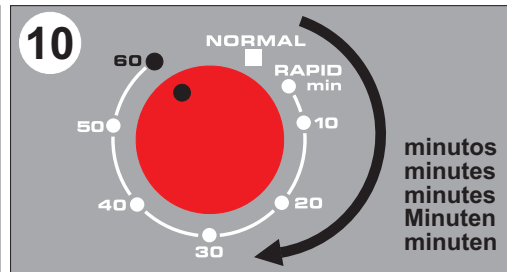
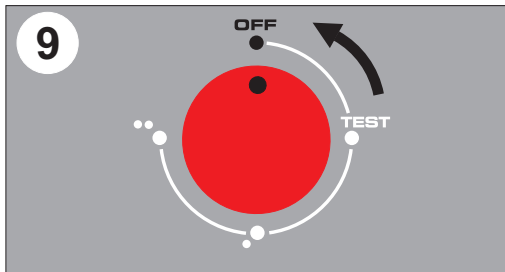
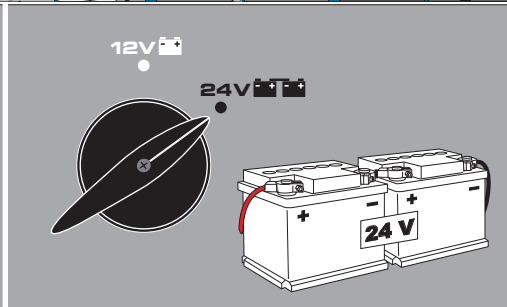
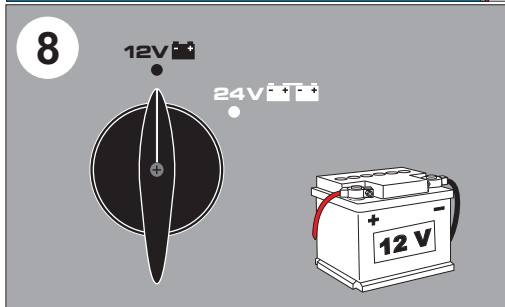
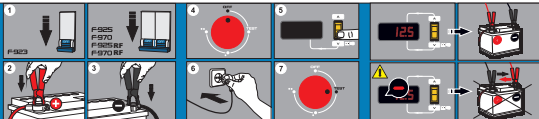

11

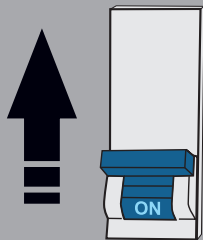

F-923

F-925
F-970
F-925 RF
F-970 RF

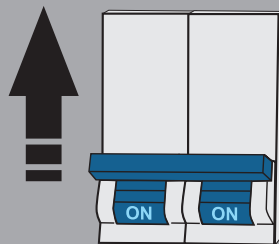

12

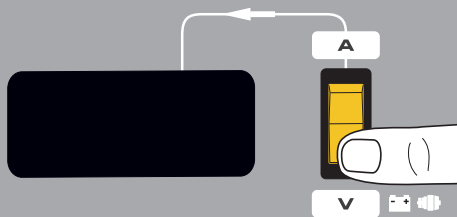

13

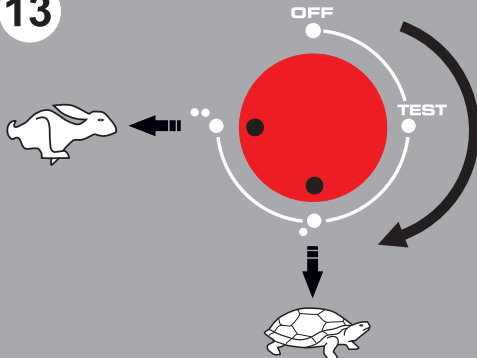

12V

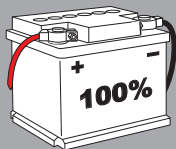

LIQUID

14.8



GEL

14.4



AGM

14.6



V



24V

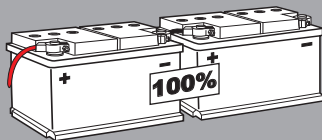

LIQUID

29.6



GEL

28.8



AGM

29.2



V



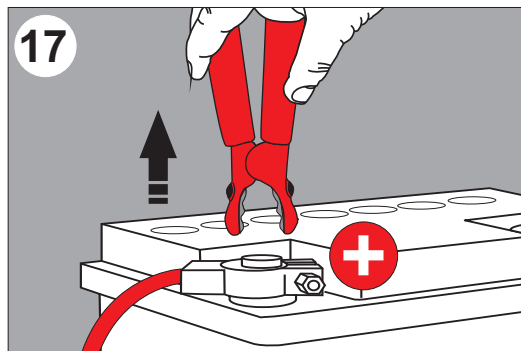
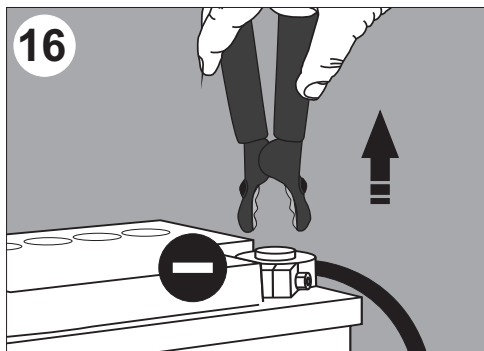
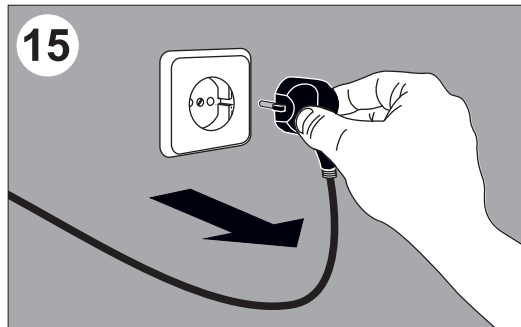
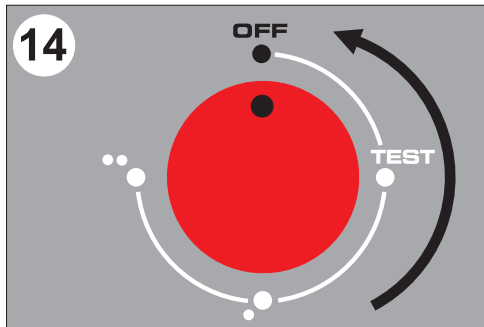

E AYUDA AL ARRANQUE

GB BOOSTER

F AIDE AU DÉMARRAGE

D STARTHILFE

NL STARTHULP

1 - 7 PAG. 8-10

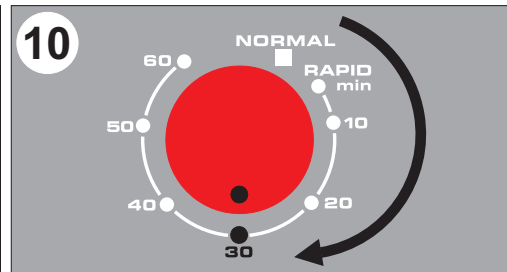
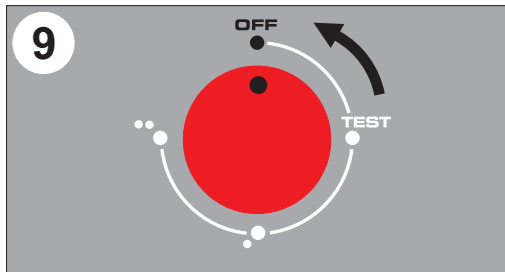
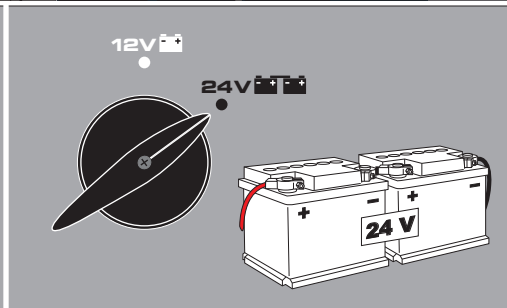
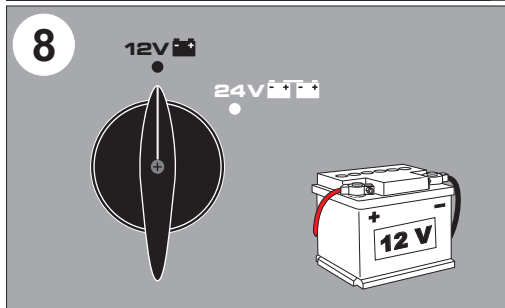
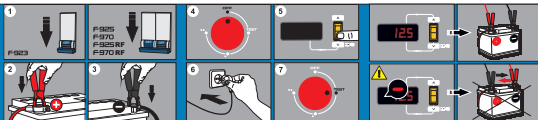

11

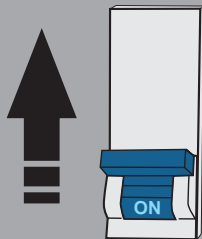

F-923

F-925
F-970
F-925 RF
F-970 RF

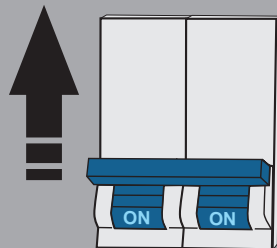

12

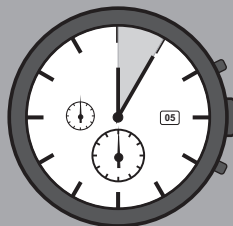
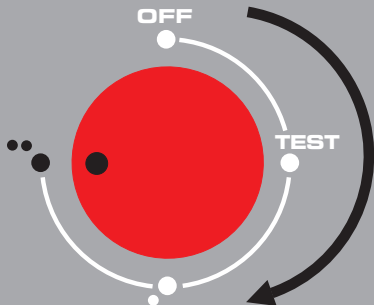

5 min.

13

F-923
F-925
F-925 RF

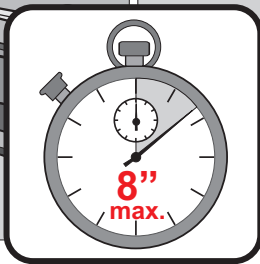
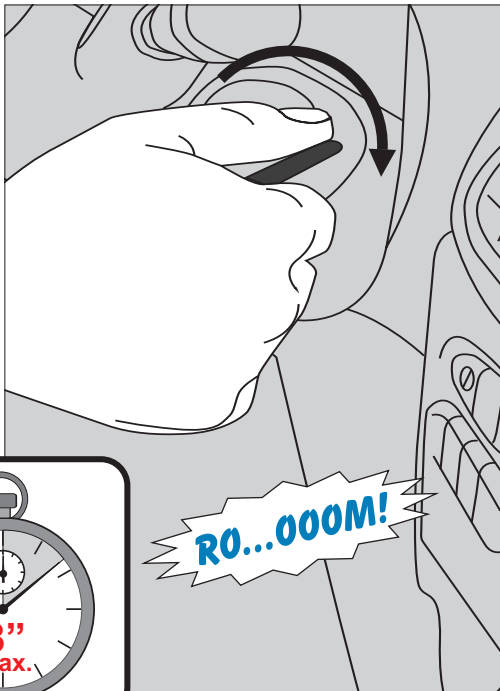
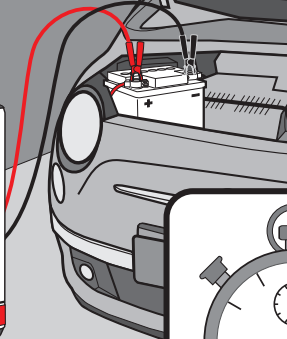
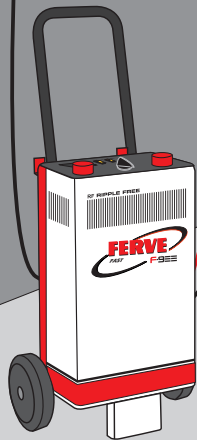

13

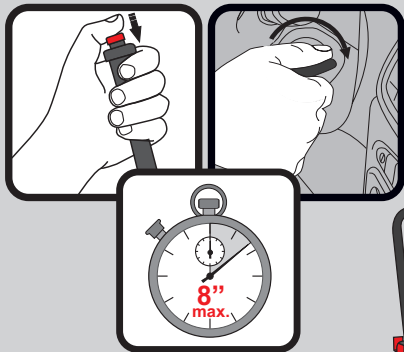

F-970
F-970 RF

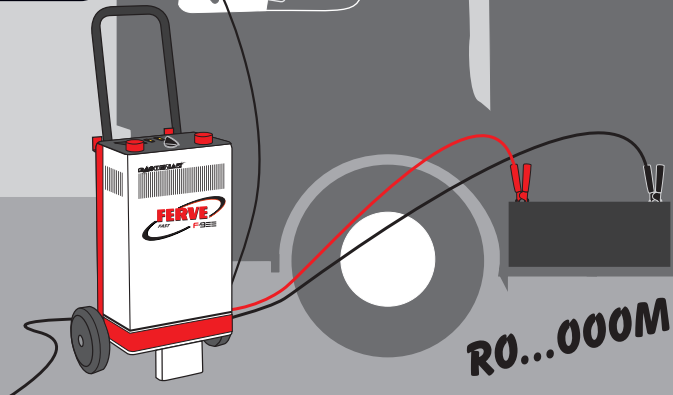

RO...000M!

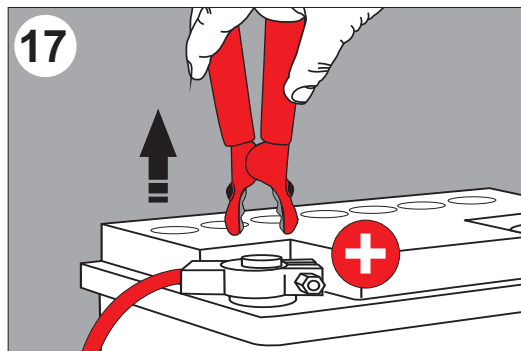
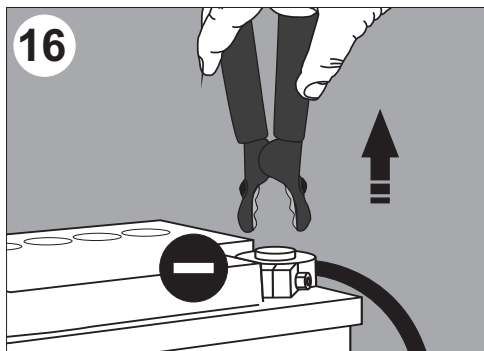
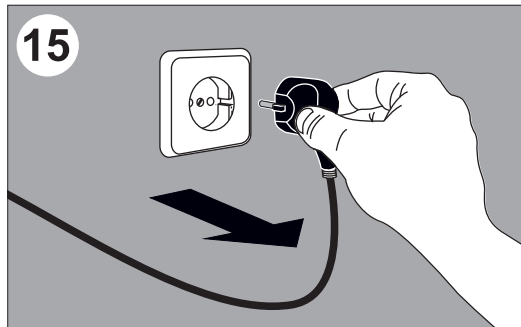
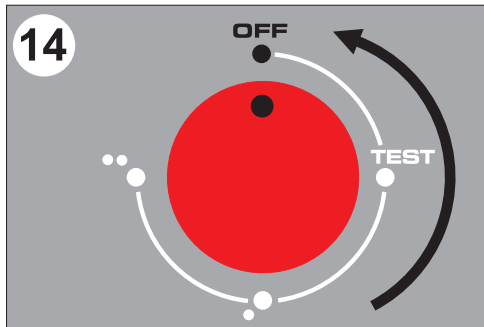



**DECLARACIÓN DE CONFORMIDAD
DECLARATION OF CONFORMITY
DÉCLARATION DE CONFORMITÉ
KONFORMITÄTSEKLRÄRUNG
CONFORMITEITSVERKLARING**

Nosotros, We, Nous, Wir, Wij

FERVE, S.A.

declaramos, bajo nuestra única responsabilidad, que el producto
declare, under our sole responsibility, that the product
déclarons, sur notre seule responsabilité, que le produit
erklären, in alleiniger Verantwortung, daß das Produkt
verklaren, onder onze eigen verantwoordelijkheid, dat de producten

Cargadores de baterías / Battery chargers / Chargeurs de batteries / Batterieladegeräte / Acculaders

F-923, F-925, F-925RF, F-970, F-970RF

al cual esta declaración se refiere, es conforme a la siguiente norma:
to which this declaration relates, is in conformity with the following standard:
auquel se réfère cette déclaration, est conforme à la norme :
auf das sich diese Erklärung bezieht, mit der folgenden Norm:
waar deze verklaring zich op richt, in overeenstemming is met de volgende standaard:

EN 60335 - 1: 2012/A11: 2014

EN 60335 - 2 - 29: 2006/A2: 2010

según las disposiciones de la Directiva:
following the provisions of Directive:
conformement aux dispositions de Directive :
Gemäß den Bestimmungen der Richtlinie:
volgens de richtlijn:

2014/35/EU

E GARANTÍA

FERVE garantiza este aparato contra todo defecto de fabricación o de las piezas durante un periodo de 36 meses a partir de la fecha de compra. Quedan excluidos los daños provocados por errores de manejo, suciedad, conexión o energía inadecuada, accidentes y en general aquellos que provengan de causas externas al aparato. Cualquier otra prestación comprometida por el distribuidor será de la exclusiva responsabilidad del mismo. El presente documento tampoco cubre los deterioros ocasionados a otros bienes como consecuencia de un defecto del aparato garantizado. Esta garantía solamente tendrá validez acompañada de la factura de compra original o el recibo del establecimiento. Esta garantía perderá su vigencia cuando el aparato sea manipulado por personal o talleres ajenos a nuestros servicios técnicos.

GB WARRANTY

FERVE warrants this device against all-defective or faulty manufacturing or parts for a period of 36 months as of the purchase date. This warranty excludes damages caused by mishandling, dirt and filth, improper connection or power, accidents and, in general, any damages arising from causes that are external to the device. Any other warranty performance agreed to by the distributor shall be the exclusive liability of this party. Furthermore, this document does not cover wear or damage caused to other goods or assets as a result of a fault in the device under warranty. This warranty is only valid when accompanied by the original invoice or sales receipt. This warranty shall lose validity if the device is handled by personnel or shops not related to our technical service.

F GARANTIE

FERVE garantit cet appareil contre tout défaut de fabrication ou des pièces pendant une période de 36 mois à compter de la date d'achat. Sont exclus les dommages provoqués par des erreurs de manipulation, de la saleté, un branchement ou une source d'énergie incorrects, des accidents et, en règle générale, tous les dommages provoqués par des causes ne concernant pas l'appareil. Toute autre prestation de garantie engagée par le distributeur sera sous sa seule responsabilité. Ce document ne couvre pas non plus les détériorations occasionnées à d'autres biens suite à un défaut de l'appareil sous garantie. Cette garantie est valable seulement avec la présentation de la facture original ou le reçu de vente. Cette garantie perdra sa validité si l'appareil est manipulé par du personnel ou des ateliers n'appartenant pas à nos services techniques.

D GARANTIE

FERVE gewährt eine Garantie auf dieses Gerät, welche jeglichen Herstellungsfehler bzw. Fehler an den Teilen über einen Zeitraum von 36 Monaten ab Kaufdatum abdeckt. Zudem sind von der Garantie Beschädigungen aufgrund von Handhabungsfehlern, Verschmutzung, unsachgemäßem Anschluß bzw. ungeeigneter Energiezufuhr, Unfälle und im allgemeinen jene Beschädigungen und Unfälle, die aufgrund von geräteexternen Ursachen hervorgerufen wurden, ausgeschlossen. Jede weitere Garantieleistung, zu der sich der Verkäufer verpflichtet, fällt ausschließlich in dessen Verantwortungsbereich. Dieses Dokument deckt ebensowenig die Schäden an anderen Gütern ab, die sich infolge eines Fehlers des durch die Garantie abgedeckten Gerätes ergeben könnten. Diese Garantie ist nur gültig, wenn sie von der ursprünglichen Rechnung begleitet wird, oder Verkäufe quittieren. Diese Garantie verliert ihre Gültigkeit, wenn am Gerät Eingriffe durch Personal Oder Werkstätten, die nicht unserem technischen Service angehören, vorgenommen wurden.

NL GARANTIE

FERVE garandeert dat dit apparaat vrij is van defecten, in onderdelen of constructie, gedurende 36 maanden na datum van aankoop. Uitgesloten van de garantie is de schade die het gevolg is van een verkeerde bediening, vuil, niet geschikte aansluiting of voedingsbron, ongevallen en in het algemeen alle schade die door externe oorzaken aan het apparaat veroorzaakt is. Elke andere garantiebepaling die met de distributeur overeengekomen is, valt geheel en uitsluitend onder de verantwoordelijkheid van de distributeur. De garantie dekt geen schade aan andere goederen die het gevolg zijn van een defect van het apparaat, voorwerp van de garantie. Zulks waarborg zit uitsluitend vigerend wanneer vergezeld tegen naar de originele factuur of Omzet stortingsbewijs. Deze garantie verliest haar geldigheid wanneer het apparaat door personeel of werkplaatsen behandeld wordt die niet door ons erkend zijn.

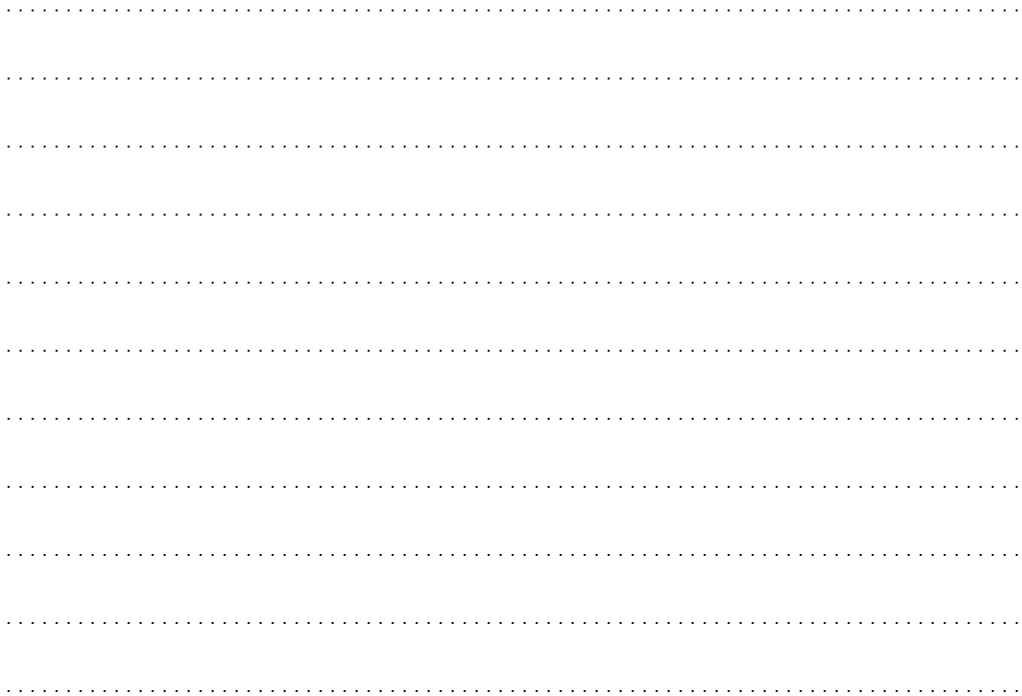



FERVE

FERVE, S.A

Ctra. de Calafell, 15-25 - Apartado (P.O. Box) 7
43700 El Vendrell (España)

Tel. +34 977 660 500 - Fax +34 977 661 160

ferve@ferve.com

www.ferve.com

2092501-0122